

Stability

Without Compromise,

Yet Saving Space

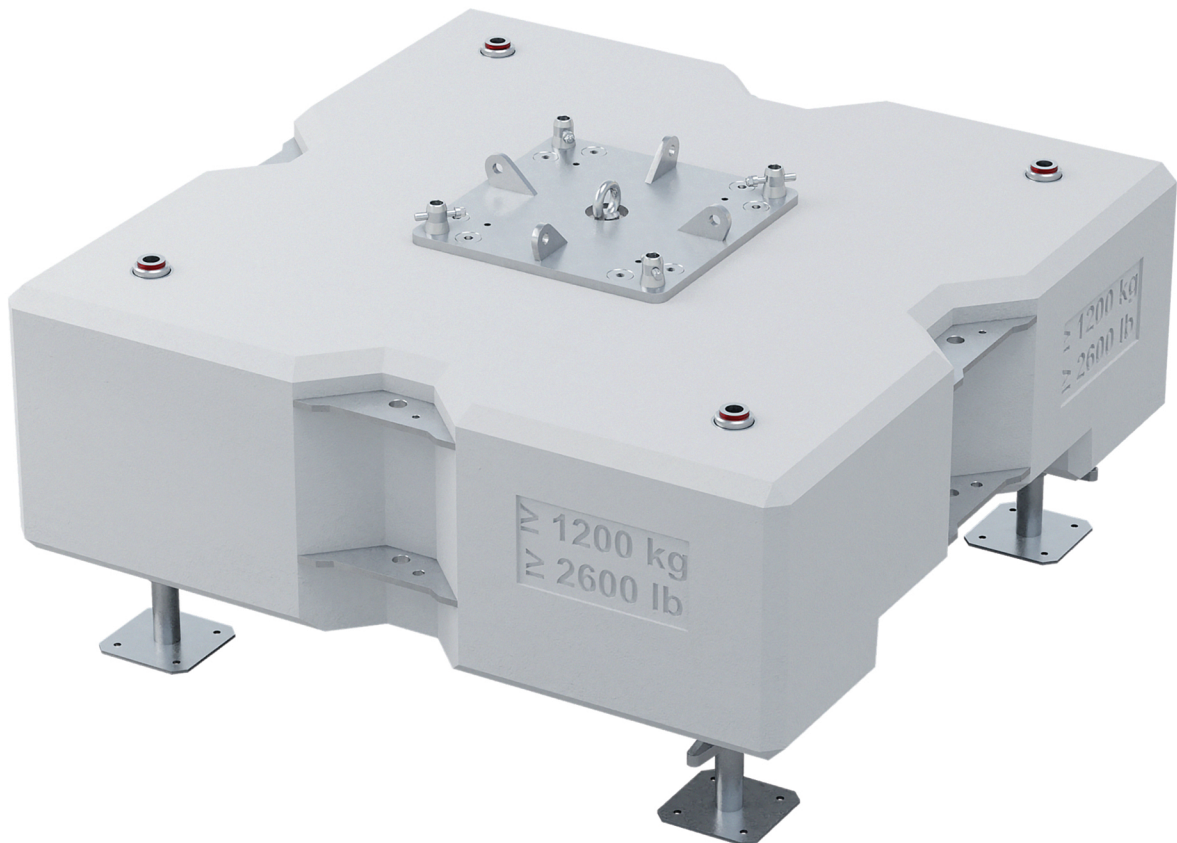

- Available versions 1200kg or 500kg weight
- Stackable for extra weights or for easier transport
- Easy manipulation due to Center Hanging point.
- Forklift pockets for easy moving and stacking
- Stackable for extra weights/for easier transport
- Integrated adjustable screwjack sleeve tube for leveling
- 1200x1200x400mm or 800x800x400m steel reinforced concrete block
- M290&M390 Truss connection via thick steel plate including lugs for wires

Secure your construction

Horizontal connector
MCBB-CON-Horizontal

Connectible to create heavier
ballast with large footprint

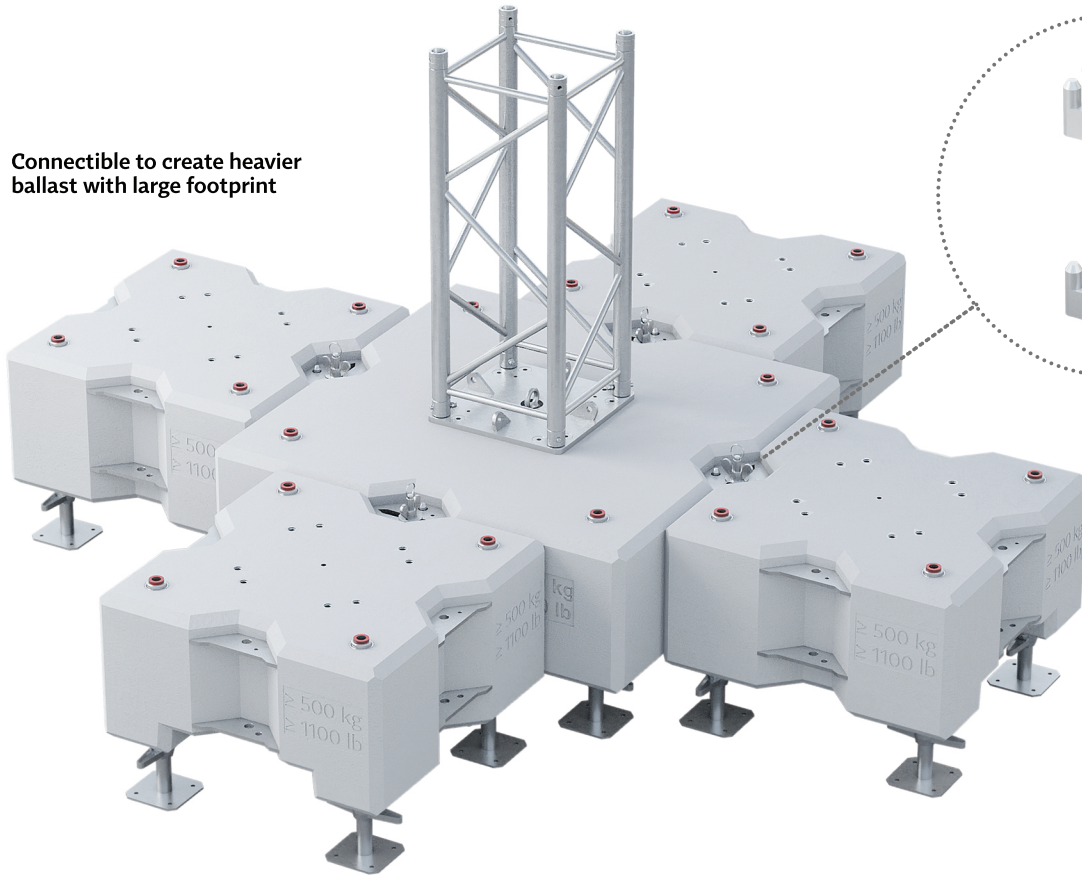

Stackable for
extra weights

Vertical connector
MCBB-CON-Vertical

